

NORTH POINT

CABINETS®



Thoughtfully Designed, Carefully Crafted

NorthPoint Cabinetry boasts a wide array of high-quality cabinet combinations allowing you to design the perfect kitchen or bath that works for your family’s lifestyle. Make the kitchen or bath high-functioning and stunningly beautiful by adding Hardware Resources’ vast selection of cabinet organizers, LED cabinet lighting, and knobs and pulls.

NorthPoint Cabinetry is an industry-leading brand of Dimora Brands, which also includes Top Knobs, Atlas Homewares, Watermark Designs, Water Street Brass, Vesta Fine Hardware, Task Lighting, Jeffrey Alexander, Elements, and Hardware Resources. As such, you can expect high-quality products, fast delivery, and excellent customer service.

Table of Contents

Our Collections	2–3
Quality Comes First.	4–7
Expert Finishing	8–9
Our Door Styles	
Catalina	12–21
Maui	22–29
Hatteras.	30–37
Versatile Vanity Cabinets.	38–41
Cabinets for Any Space	42–45
Personalize Your Space	
Moulding	46–47
Fillers & Panels.	48–49
Design Elements.	50–51
Specialty Cabinets.	52–53
The Finishing Touches	
Decorative Cabinet Hardware	56–63
Cabinet Organizers	64–71
Stainless Steel Sinks.	72–73
Cabinet Lighting	74–79
Manufacturing & Technical Information	
Cabinet Breakdown	80–81
Cabinet Lineup.	82–83
What is QuickBuild?	85



Cabinets: Catalina Polar White

Island: Catalina Slate

Decorative Cabinet Hardware: Key Grande Collection in Matte Black with Satin Nickel

Our Collections



PREMIER Collection

Pages 12 – 27

The Premier Collection features elegant upgrades like soft-close doors and drawers that won't slam when closed.

Door Styles: Catalina, Maui

- High-quality wood construction
- 3/4" thick shelves
- Beautiful, finished interior
- 5-Year limited warranty

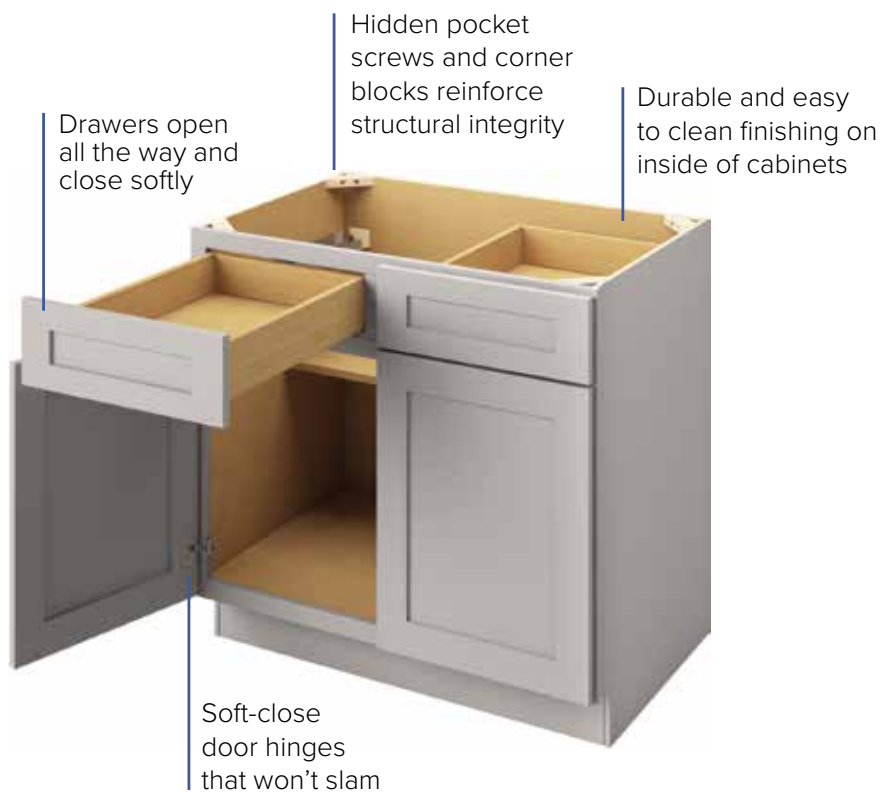



ESSENTIALS

Collection

Pages 28 – 33

The Essentials Collection features reliable hardware and sturdy construction that create a quality cabinet at a great value.

Door Style: Hatteras

- High-quality wood construction
- 3/4" thick shelves
- Beautiful, finished interior
- 1-Year limited warranty

Drawers open all the way for full access to the space

Durable and easy to clean finishing on inside of cabinets



Concealed self-close hinges create a seamless look

Hatteras Profile

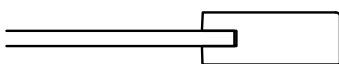

Quality Comes First

Your choice of cabinetry makes a personality-defining statement in your home. Selecting the right cabinets is an important first step because your cabinets should be just as functional on the inside as they are beautiful on the outside. Cabinets should withstand the demands of daily use and maintain their integrity throughout their lifetime.

That's why quality comes first at NorthPoint Cabinetry. Every detail is carefully considered to ensure our cabinets not only meet our high quality standards, but yours as well. Our commitment to quality combined with our on-trend finishes, door styles, and product depth and breadth are what make NorthPoint Cabinetry the perfect choice for your project.

It Starts with Quality Wood

Just as a healthy tree needs strong roots to thrive, a quality cabinet requires premium lumber at its core. The quality of wood is of utmost importance, so our cabinets feature all-wood construction.



Structural Integrity

Meaningful yet hidden reinforcements—like solid wood corner blocks and strategically placed pocket screws—help reinforce the structural integrity of the cabinet. Take comfort that these well-constructed cabinets will stand the test of time.

Thoughtful Craftsmanship

These cleverly designed cabinets boast an innovative dovetail and hidden pocket screw construction that provides robust quality and quick, accurate assembly.





Pretty on the Inside, Too

NorthPoint Cabinetry features a clean and beautifully finished birch interior that enhances the cabinet's luxurious, high-quality appeal.

Premium Drawer Boxes

Dovetail joinery is the hallmark of high-quality drawer boxes. The UV finish of the drawer, dovetail construction, and smooth concealed slides are synonymous with quality furniture.





Hardworking Hardware

Our cabinets feature discreet compact hinges and concealed undermount slides. The hinges and slides have been third-party tested and exceed industry standards. The Premier Collection (shown) features full extension slides, allowing for easy access and use of the whole drawer.

Sturdy Shelves

NorthPoint Cabinetry shelves are constructed from an impressive ¾" thick veneered plywood, preventing sagging over time under the weight of normal use. Shelf height is adjustable, so the homeowner can optimize storage space.



Expert Finishing

Count on consistent, high-quality finishing. Our state-of-the-art manufacturing facility utilizes a multi-step professional finishing process. This meticulous process maintains a high degree of color and application accuracy from cabinet to cabinet, ensuring a beautiful run of cabinets when installed.

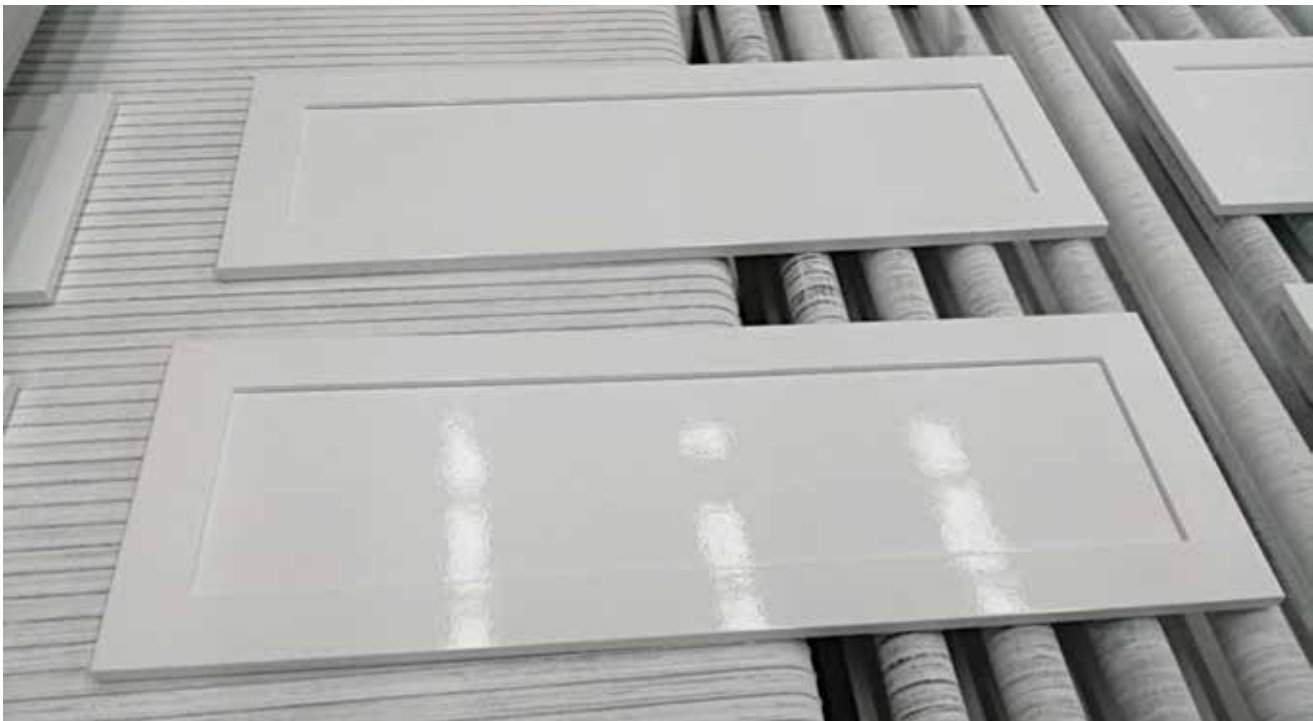

CATALINA FINISHES



POLAR WHITE
(PAINTED)



PEBBLE GREY
(PAINTED)



NEW SANDSTONE
(STAINED)



SLATE
(STAINED)



ESPRESSO
(STAINED)

MAUI FINISHES



POLAR WHITE
(PAINTED)



PEBBLE GREY
(PAINTED)



SLATE
(STAINED)



ESPRESSO
(STAINED)

HATTERAS FINISHES



POLAR WHITE
(PAINTED)



PEBBLE GREY
(PAINTED)



SLATE
(STAINED)



ESPRESSO
(STAINED)

DOOR STYLES

CATALINA

Premier Collection

More than modern.
The Catalina door style features
a full-overlay, Shaker style door
and 5-piece drawer front.

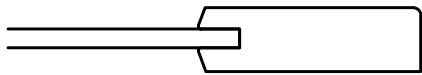

Pebble Grey

MAUI

Premier Collection

Sometimes the details make all
the difference. The Maui door style
features a full-overlay, transitional
door and 5-piece drawer front
with a twist of character.



Pebble Grey

HATTERAS

Essentials Collection

Simple and sleek.
The Hatteras door style features
a partial-overlay, Shaker style
door and slab drawer front.

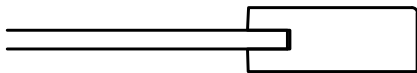

Pebble Grey

Catalina in
stained
Espresso

Maui in
stained
Slate

Catalina
in stained
Sandstone

Maui
in painted
Pebble Grey

Hatteras
in painted
Polar White

PREMIER COLLECTION: CATALINA



CATALINA

SANDSTONE FINISH

*Island cabinets shown
in Catalina Polar White*

**NORTH
POINT**
CABINETS®



Decorative Cabinet Hardware: Sullivan Collection in Matte Black



PREMIER COLLECTION: CATALINA



CATALINA

SLATE
FINISH

**NORTH
POINT**
CABINETS®



Decorative Cabinet Hardware: Dominique Collection in Satin Bronze



PREMIER COLLECTION: CATALINA



CATALINA

ESPRESSO
FINISH

*Wall cabinets shown
in Catalina Polar White*

**NORTH
POINT**
CABINETS®



Decorative Cabinet Hardware: Tiffany Collection in Satin Bronze



PREMIER COLLECTION: CATALINA



CATALINA

POLAR WHITE
FINISH

*Island cabinets shown
in Catalina Espresso*

**NORTH
POINT**
CABINETS[®]



Decorative Cabinet Hardware: Hadly Collection in Matte Black



PREMIER COLLECTION: CATALINA



CATALINA

PEBBLE GREY
FINISH



**NORTH
POINT**
CABINETS®

Decorative Cabinet Hardware: Katharine Collection in Brushed Pewter



PREMIER COLLECTION: MAUI



MAUI

SLATE FINISH

*Island cabinets shown
in Maui Polar White*

**NORTH
POINT**
CABINETS®



Decorative Cabinet Hardware: Belcastel 1 Collection in Matte Black



PREMIER COLLECTION: MAUI



MAUI

ESPRESSO FINISH*

*Island cabinets shown
in Maui Polar White*

**Call for availability*

**NORTH
POINT**
CABINETS[®]



Decorative Cabinet Hardware: Leyton Collection in Satin Nickel



PREMIER COLLECTION: MAUI



MAUI

POLAR WHITE FINISH

*Island cabinets shown
in Maui Espresso*



**NORTH
POINT**
CABINETS[®]

Decorative Cabinet Hardware: Knox Collection in Satin Nickel



PREMIER COLLECTION: MAUI



MAUI

PEBBLE GREY FINISH

*Island cabinets shown
in Maui Espresso*



**NORTH
POINT**
CABINETS[®]

Decorative Cabinet Hardware: Boswell Collection in Matte Black



ESSENTIALS COLLECTION: HATTERAS



HATTERAS

SLATE
FINISH

**NORTH
POINT**
CABINETS®



Decorative Cabinet Hardware: William Collection in Satin Nickel



ESSENTIALS COLLECTION: HATTERAS



HATTERAS

ESPRESSO
FINISH

**NORTH
POINT**
CABINETS®



Decorative Cabinet Hardware: Sutton Collection in Polished Chrome



ESSENTIALS COLLECTION: HATTERAS



HATTERAS

POLAR WHITE
FINISH

*Island cabinets shown
in Hatteras Pebble Grey*

**NORTH
POINT**
CABINETS®



Decorative Cabinet Hardware: Naples Collection in Brushed Gold



ESSENTIALS COLLECTION: HATTERAS



HATTERAS

PEBBLE GREY
FINISH

**NORTH
POINT**
CABINETS®



Decorative Cabinet Hardware: Gibson Collection in Matte Black



Versatile Vanity Cabinets

Our kitchen and vanity cabinets are made with the same dependable quality and construction. The vanity door styles and finishes match our kitchen cabinet collections, which allows you to design coordinated spaces and create an intelligent design flow from kitchen to bathroom. Mix up the design styles and finishes from room to room if that best fits the design personality.

We offer many different vanity cabinet configurations that allow our cabinets to perfectly fit most bathroom spaces. Options like linen cabinets and all-drawer cabinets go the extra mile to make the bathroom space functional and beautiful.



Catalina Polar White Cabinets

Decorative Cabinet Hardware: Tahoe Collection in Black

Create the Perfect Vanity

Our cabinets are designed to mix and match for a customized solution to fit your lifestyle. Need more drawers? No problem. Prefer one sink and lots of counter space? We've got you covered. Here are some popular combinations to get you started designing the perfect vanity for your project.

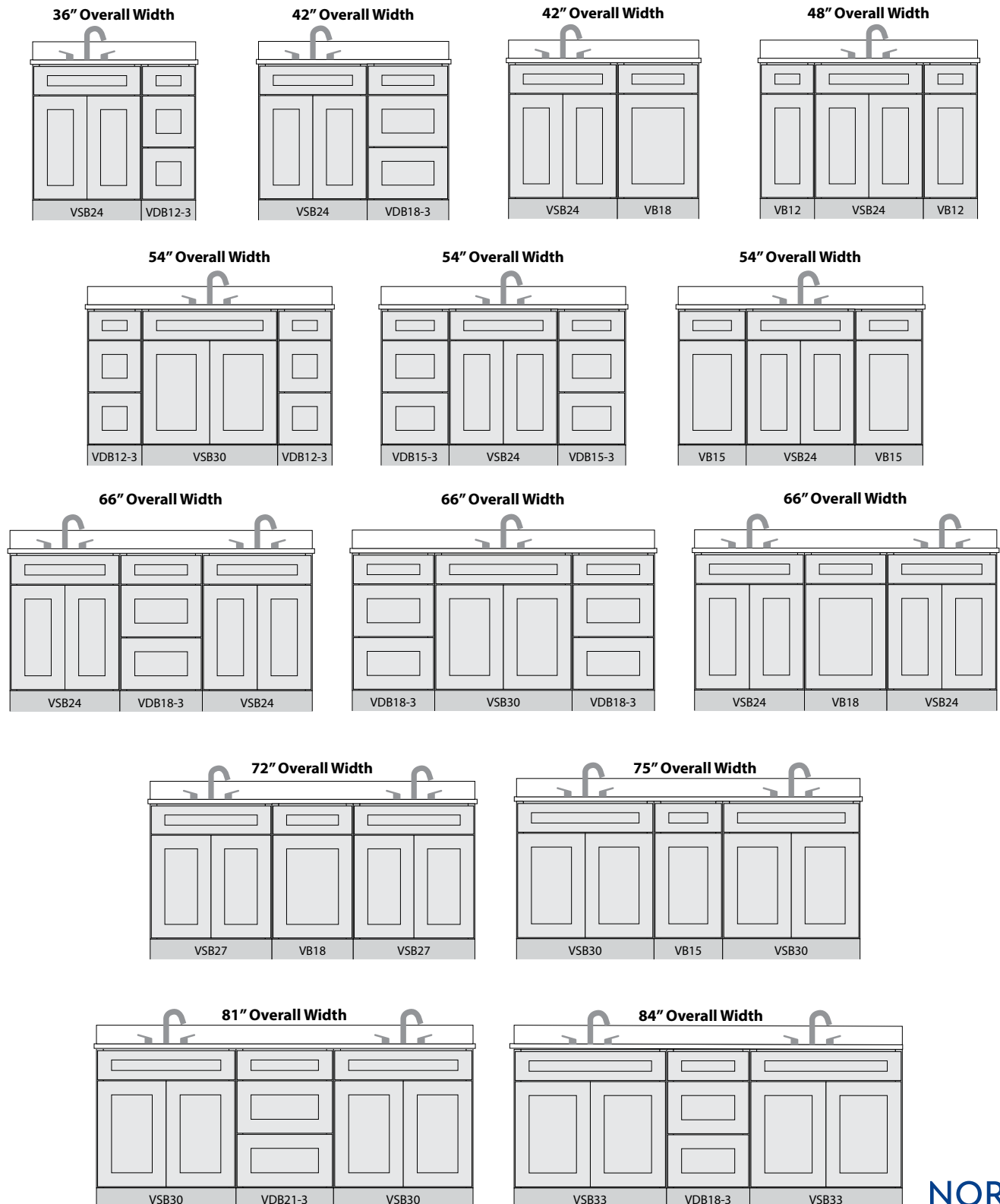

Catalina Polar White Cabinets
Decorative Cabinet Hardware:
Cordova in Satin Nickel





Catalina Espresso Cabinets
Decorative Cabinet Hardware: Hadly in Satin Bronze



Maui Pebble Grey Cabinets
Decorative Cabinet Hardware: Marie in Satin Bronze

Cabinets for Any Space

The kitchen and bath are common spaces to install cabinetry. However, NorthPoint Cabinetry provides solutions for other spaces like the laundry room, mudroom, and entertainment areas. Cabinets make those areas more functional by providing additional storage and countertop work space.



Beverage Bar

Catalina Sandstone Cabinets

Decorative Cabinet Hardware: Roman Collection in Matte Black



Mudroom

Maui Polar White Cabinets
Decorative Cabinet Hardware:
Ella Collection in Brushed Oil
Rubbed Bronze
Decorative Hooks:
Emerald Backplate in
Brushed Oil Rubbed Bronze



Laundry Room

Catalina Slate Cabinets
Decorative Cabinet Hardware:
Hudson Collection
in Satin Nickel

Butler's Pantry

Catalina Polar White Cabinets
Decorative Cabinet Hardware:
Wheeler Collection in Matte Black





Closet

Catalina Pebble Grey Cabinets
Decorative Cabinet Hardware: Merrick Collection in Satin Nickel



Entertainment Center

Catalina Espresso Cabinets
Decorative Cabinet Hardware: Rae Collection in Satin Nickel

Personalize Your Space - Moulding

Add the finishing touch to your cabinets with our broad selection of finished mouldings. Light rail moulding allows under-cabinet task lighting to be neatly tucked out of sight, while our selection of crown mouldings, from cove to classic, adds a level of beauty and sophistication to the room. We offer many different types of decorative and utility mouldings in all finishes to accentuate and complete the space.

LIGHT RAIL

Available in all finishes:
Polar White, Pebble Grey,
Espresso, Slate, and Sandstone



FINISH MOULDINGS

Available in all finishes: Polar White, Pebble Grey, Espresso, Slate, and Sandstone





Cove Crown Look



Angled Crown Look



Classic Crown Look



Personalize Your Space - Fillers & Panels

We offer a variety of fillers including standard, fluted, and overlay, as well as decorative end panels to help complete the cabinets with style. Create smooth transitions in cabinet layouts with fillers. Use decorative end panels to add character and a finish touch to your design. Utility panels, like refrigerator end panels, dishwasher end panels, and island back panels accommodate endless kitchen layouts. *More options available. See our Specification Guide for complete offering.*



FLUTED FILLER

3/4" Thick Material

Available in all finishes:
Polar White, Pebble Grey,
Espresso, Slate, and Sandstone

BEADBOARD PANELS

1/4" Thick Material

Available in all finishes:
Polar White, Pebble Grey,
Espresso, Slate, and Sandstone





WALL, BASE & REFRIGERATOR END PANELS

Available in all finishes:
Polar White, Pebble Grey,
Espresso, Slate, and Sandstone

DECORATIVE END PANELS

Available in all finishes & door styles:
Polar White, Pebble Grey,
Espresso, Slate, and Sandstone



Personalize Your Space - Design Elements

Your cabinets should reflect your style. Our wide variety of decorative wood accessories adds a touch of character to the cabinet design. Whether your ideal space is traditional, transitional, or contemporary, we have the selection available to transform the space from “blah” to “ahhh!” *More options available. See our Specification Guide for complete offering.*



CORBELS

Available in all finishes:
Polar White, Pebble Grey,
Espresso, Slate, and Sandstone



DECORATIVE LEGS

Available in all finishes:
Polar White, Pebble Grey,
Espresso, Slate, and Sandstone





BUN & TAPERED FEET

Available in all finishes:
Polar White, Pebble Grey,
Espresso, Slate, and Sandstone



SCALLOPED OR ARCHED VALANCE

Available in all finishes:
Polar White, Pebble Grey,
Espresso, Slate, and Sandstone



Personalize Your Space - Specialty Cabinets

Our wide selection of specialty cabinets expands the functionality to fit your lifestyle. Whether you need an elegant storage solution for your bottles of wine or want a space to display your trendy decorative plates, we have the solutions that work for you. *More options available. See our Specification Guide for complete offering.*



Wine Rack



Plate Rack



Microwave Wall Cabinet



Microwave Base Cabinet





RANGE HOODS

Available in all finishes:
Polar White, Pebble Grey,
Espresso, Slate, and Sandstone

FARMHOUSE SINK BASE CABINET

Available in all finishes & door styles:
Polar White, Pebble Grey,
Espresso, Slate, and Sandstone



GLASS DOOR CABINETS

Only available in the Premier collection
door styles, Catalina & Maui

Available in all finishes:
Polar White, Pebble Grey,
Espresso, Slate, and Sandstone

Cabinets come with matching interiors and
a clear glass center panel



The Finishing Touches

Knobs & Pulls • Organizers
Cabinet Lighting • Hidden Power • Sinks





Knobs & Pulls

JEFFREY ALEXANDER[®]
by Hardware Resources

E L E M E N T S[®]
by Hardware Resources

Cabinets from NorthPoint Cabinetry are not complete without Jeffrey Alexander or Elements cabinet knobs and pulls! Your clients can personalize their space—really bringing their style to life. Cabinet knobs and pulls often take center stage by adding the finishing touch on the perfect design. There are **thousands of different knobs and pulls to choose from** in various sizes, finish options, and price points so that they can achieve that perfect look.

See our full offering of cabinet knobs & pulls in the Hardware Resources Designer Edition Catalog.



Matte Black Pulls

Jeffrey Alexander Sullivan Collection
Catalina Sandstone Cabinets



For more information on
Knobs & Pulls, scan the QR code
or visit <https://delivr.com/2fk7w>



Satin Bronze Pulls

Jeffrey Alexander Dominique Collection
Catalina Slate Cabinets



Satin Nickel Pulls

Jeffrey Alexander Merrick Collection
Catalina Pebble Grey Cabinets



Brushed Gold Pulls

Elements Naples Collection
Hatteras Polar White Cabinets

Popular Styles in Satin Nickel



Belcastel Collection



Boswell Collection



Dominique Collection



Florence Collection



Glendale Collection



Hadly Collection



Hayworth Collection



Kenner Collection



Knox Collection



Madison Collection



Merrick Collection



Naples Collection



Roman Collection



Somerset Collection



Stanton Collection



Sullivan Collection



Sutton Collection



Thatcher Collection



Tiffany Collection

Popular Styles in Polished Chrome



Belcastel Collection



Boswell Collection



Dominique Collection



Florence Collection



Glendale Collection



Hadly Collection



Hayworth Collection



Kenner Collection



Knox Collection



Madison Collection



Merrick Collection



Naples Collection



Roman Collection



Somerset Collection



Stanton Collection



Sullivan Collection



Sutton Collection



Thatcher Collection



Tiffany Collection

To see more styles, lengths, and finishes, visit www.HardwareResources.com for more information.



**NORTH
POINT**
CABINETS®

Popular Styles in Matte Black



Belcastel Collection



Boswell Collection



Dominique Collection



Florence Collection



Glendale Collection



Hadly Collection



Hayworth Collection



Kenner Collection



Knox Collection



Madison Collection



Merrick Collection



Naples Collection



Roman Collection



Somerset Collection



Stanton Collection



Sullivan Collection



Sutton Collection



Thatcher Collection

Popular Styles in Satin Bronze



Belcastel Collection



Dominique Collection



Florence Collection



Glendale Collection



Hadly Collection



Hayworth Collection



Madison Collection



Merrick Collection



Naples Collection



Roman Collection



Somerset Collection



Stanton Collection



Sutton Collection



Thatcher Collection



Tiffany Collection

To see more styles, lengths, and finishes, visit www.HardwareResources.com for more information.



Long Cabinet Pulls Look Best

Cabinet knobs and pulls come in a variety of sizes, styles and finishes. But which ones should you choose?

You could decide to use all cabinet pulls. Or you may prefer the look of all cabinet knobs. Or you can mix knobs and pulls in your kitchen. Which one is right? They all are. All it comes down to is your personal preference.

Best Look



To achieve a cohesive & finished look, select a pull that's proportional in length to the cabinet door or drawer. Shorter doors & drawers use shorter pulls; longer doors & drawers use longer pulls.

Better Look



Catalina Pebble Grey Cabinets
Decorative Cabinet Hardware: Roman Collection in Matte Black

Good Look



Catalina Pebble Grey Cabinets
Decorative Cabinet Hardware: Roman Collection in Matte Black



For more information on selecting knobs & pulls, scan the QR code or visit <https://delivr.com/2fk7w>

Create an Organized & Efficient Kitchen

Cabinet design is not only about aesthetics—functionality of the space is an important factor. Improve your client's experience with Organizers that conquer clutter and make reaching items easy and efficient. See our full offering of Organizer products in the Hardware Resources Designer Edition Catalog.

Neatly Tuck Away Trash Cans

Pick a trash can solution that best fits your kitchen and your budget.

- Wood Bottom Mount Trash Can
- Economy Soft-Close Trash Can
- Storage with Style® Trash Can Pullout

✓ POPULAR



✓ POPULAR



Organization Within Reach

Maximize cabinet storage with base cabinet organizers. Choose pullout organizers to maximize storage and eliminate the reach.

- "No Wiggle" Base Pullout
- "No Wiggle" Utensil Pullout
- "No Wiggle" Knife Pullout



For more information on cabinet organizers, scan the QR code or visit <https://delivr.com/272ju>



Corner Storage That Comes To You

Bring the deep recesses of corner cabinets forward with corner organizers.

- Easy 360 Susan
- Half-moon Lazy Susan
- Storage with Style® Blind Corner Pullout

Tame Drawer Clutter

Drawer inserts help organize everything from cutlery to spices to dishes.

- SlimLine Cutlery Drawer Insert
- Spice Rack Drawer Insert
- Coffee Pod Drawer Insert

✓ POPULAR



Organize Heavily Used Cabinets

Go from disorder to order with solutions for challenging storage areas.

- Easy Access Pantry Pullout
- Double Drawer Bottle Rollout
- Mixer Lift

Organize Your Whole Kitchen





For more information on cabinet organizers, scan the QR code or visit <https://delivr.com/272ju>

Storage with Style[®] Organizer Collection

Storage solutions that beautifully coordinate to create a harmonious kitchen design



Design is in the details

Curved flat wire design details flow across all organizers to create a cohesive collection identity

Stylish finish options

Designer finishes of Black Nickel & Polished Chrome coordinate with popular hardware styles, or mix finishes to add variety





Storage with Style® Trash Can Pullout



Storage with Style® Base Pullout



Storage with Style® Drawer Base Pullout



Storage with Style® Utensil Pullout



Storage with Style® Blind Corner Pullout



Storage with Style® Pot & Lid Pullout



Storage with Style® Pullout Baskets



For more information on cabinet organizers, scan the QR code or visit <https://delivr.com/272ju>



NORTH POINT
CABINETS



1 POWERED VANITY DRAWER

Convert a vanity drawer into a hairstyling workstation where hair appliances can stay plugged in and ready to go when needed. Simply plug the drawer into an outlet behind the vanity for easy installation that doesn't require an electrician.

Fits in 18" wide cabinets



2 VANITY DEPTH DRAWER INSERT

Drawer inserts aren't just for the kitchen. Organize a variety of beauty and grooming items in bathroom drawers with this clever insert that is adjustable and trimmable for a variety of drawer sizes.

Fits in 12" wide cabinets or larger

May require trimming

Organization Is Not Just for the Kitchen

An organized bathroom is just as important as an organized kitchen. Getting ready for the day in an organized bathroom helps to eliminate stress and save time. These organizers will help transform any bathroom into a dream spa oasis.



For more information on cabinet organizers, scan the QR code or visit <https://delivr.com/272ju>

Catalina Slate Cabinets

Decorative Cabinet Hardware: Walker 1 Collection in Satin Bronze



3 VANITY DEPTH WOOD BOTTOM MOUNT TRASH CAN

Tuck bathroom trash cans away from little hands or wandering noses with this pullout, designed for mounted-door or hinged-door applications.

Fits in 15" wide cabinets



4 "NO WIGGLE" VANITY PULLOUT

Bring "no wiggle" technology into the bathroom and tame clutter with a pullout designed with the bath in mind. With two optional inserts available, this product can be modified to suit a variety of needs.

Fits in 12" wide cabinets

Everything and the Kitchen Sink

The sink is an often-overlooked focal point in the home. Not only does a sink need to hold up against everyday life, but it should also add a look of sophistication and elegance to a room.

Hardware Resources is proud to offer a line of Stainless Steel Kitchen, Bar, and Utility sinks for the everyday home. We offer a variety of sizes and styles of sinks, all manufactured from the highest quality materials.





For more information
on stainless steel sinks,
scan the QR code or visit
<https://delivr.com/2qte5>

Add Lighting to Brighten the Kitchen



Highlight the beauty of your cabinet design with LED lighting from Task Lighting & Power. Select from a variety of assembled linear fixtures, tape lighting, puck lights, and specialty lighting—allowing your clients to set the mood in any room.



1 *Illuminate countertops with Under Cabinet Lighting*

Illuminate countertops with under cabinet lighting to enhance functional spaces, highlight beautiful backsplashes, or eliminate shadows created from cabinets. Under cabinet lighting creates ample illumination for meal prep and reading recipes.

2 *Accentuate decorative items on display with In Cabinet Lighting*

Use lighting in glass-faced cabinets to accentuate decorative items on display or highlight beautiful crystal and china. Adding lighting inside a glass door cabinet gives a nice wash of light throughout the cabinet.

3 *Highlight beautiful flooring with Toe Kick Lighting*

Add lighting under the toe kick to highlight beautiful flooring during the daytime. At night, keep floors safely illuminated with a gentle glow for midnight snacking.

4 *Add ambiance and make the space feel larger with Above Cabinet Lighting*

Add depth and ambiance to your kitchen by highlighting the open space above cabinets to increase the aesthetic appeal and make the space feel larger.



BEFORE



Catalina Polar White & Slate Cabinets

AFTER



Catalina Polar White & Slate Cabinets



For more information on Task Lighting products, scan the QR code or visit <https://delivr.com/2eqnz>

Select the Perfect White Color Temperature for Lighting Any Space

When installing lighting, it's important to select an optimal white color (Kelvin) temperature that accentuates the beauty of the space. Pro tip: Using the same color temperature lighting throughout a room gives it a clean, even feel.



Or...Use Tunable White Lighting to Easily Change the White Color Temp Any Time!



Install tunable white lighting with patented TandemLED technology to experience full tuning control of the white color temperature, from Warm White to Daylight White and all shades of white in between.



Using the wireless controller, adjust the white color temperature of tunable white lighting at any point throughout the day to match the natural lighting outside. A routine can also be set up in a Smart Home system's app to mimic the natural outdoor lighting throughout the day automatically.



"Alexa, tune the kitchen to Warm White"

OPTION: Control lights with Amazon Alexa, Google Home, Philips Hue, Apple HomeKit, or any Zigbee 3.0 compatible system.





Zigbee is a trademark of Zigbee Alliance, Davis, California. Alexa is a trademark of Amazon, Seattle, Washington. Google Home is a trademark of Googleplex, Mountain View, California. HomeKit is a trademark of Apple, Cupertino, California. These marks are not affiliated with nor approved endorsements of Task Lighting & Power.



For more information on tunable white lighting products, scan the QR code or visit <https://delivr.com/2eqnz>



Hide Unsightly Power Outlets



Angle Power Strip fixtures tuck away hidden power right where it's needed and are the perfect alternative to standard outlets that disrupt the beauty of glass, tile, or solid-surface backsplashes.



18" Black fixture*



18" Satin Nickel fixture*



18" Bronze fixture*



18" White fixture*

ASSEMBLED
IN THE
USA



5 YEAR
WARRANTY



For more information on Angle Power Strip fixtures, scan the QR code or visit www.TaskLighting.com

**Available in standard lengths from 9" to 72", custom options available*



Tucked away electrical power, plus switches to control lighting, garbage disposal

Lighted Power Strip
Combines LED lighting and angled power outlets

ASSEMBLED
IN THE
USA

Hatteras Polar White Cabinets, Hatteras Pebble Grey Island
Decorative Cabinet Hardware: Naples Collection in Brushed Gold



Angle Power Strip tucked up under the cabinet preserving the backsplash (and “disappears” when standing)

ELIMINATE THOSE UNSIGHTLY POWER OUTLETS WITH SLEEK, HIDDEN ANGLE POWER STRIP FIXTURES



Light & Power come together, out of sight beneath cabinets, with Lighted Power Strip fixtures. Now available with tunable-white lighting!

Lighted Power Strip tuned to Warm White 2700K

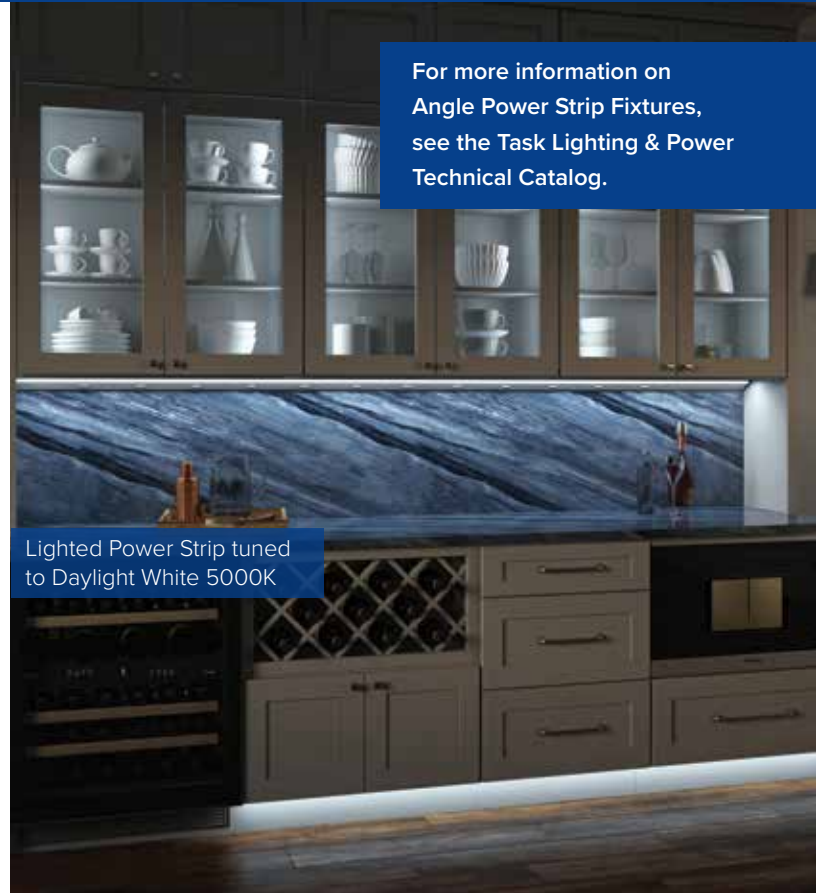

For more information on Angle Power Strip Fixtures, see the Task Lighting & Power Technical Catalog.

Lighted Power Strip tuned to Daylight White 5000K

Thoughtfully Designed. Carefully Crafted.

	<h2>PREMIER</h2> <p>Collection</p> <h3>Catalina, Maui</h3>	<h2>ESSENTIALS</h2> <p>Collection</p> <h3>Hatteras</h3>
DOOR STYLES		
A OVERLAY	<ul style="list-style-type: none"> • Full-overlay doors and drawer fronts 	<ul style="list-style-type: none"> • Partial-overlay doors and drawer fronts
B FACE FRAME	<ul style="list-style-type: none"> • 3/4" x 1-1/2" hardwood face frame 	<ul style="list-style-type: none"> • 3/4" x 1-1/2" hardwood face frame
C DOORS	<ul style="list-style-type: none"> • Stained (and Maui painted) doors are 5-piece solid wood cope-and-stick construction with a 3/4" thick, 2-3/4" wide door frame and 1/4" veneered center panel • Painted (except Maui) doors are 5-piece HDF cope-and-stick with a 3/4" thick, 2-3/4" wide door frame with 1/4" HDF center panel 	<ul style="list-style-type: none"> • Stained doors are 5-piece solid wood cope-and-stick construction with a 3/4" thick, 2" wide door frame and 1/4" veneered center panel • Painted doors are 5-piece HDF cope-and-stick with a 3/4" thick, 2" wide door frame and 1/4" HDF center panel
D HINGES	<ul style="list-style-type: none"> • 6-way adjustable soft-close concealed hinges 	<ul style="list-style-type: none"> • 6-way adjustable self-close concealed hinges
E DRAWER FRONTS	<ul style="list-style-type: none"> • 5-piece drawer fronts with 3/4" thick frame and 1/4" thick center panel 	<ul style="list-style-type: none"> • 3/4" thick slab drawer fronts
F DRAWERS	<ul style="list-style-type: none"> • 5/8" thick solid wood dovetail drawer boxes with 1/2" thick veneered plywood drawer bottom 	<ul style="list-style-type: none"> • 5/8" thick solid wood dovetail drawer boxes with 1/2" thick veneered plywood drawer bottom
G DRAWER SLIDES	<ul style="list-style-type: none"> • Premium full extension, 100 lb dynamic weight rated, adjustable undermount soft-close slides 	<ul style="list-style-type: none"> • 3/4" extension, 100 lb static weight rated, undermount epoxy slides
H SHELVES	<ul style="list-style-type: none"> • 3/4" thick veneered plywood adjustable shelves – half depth in base cabinets • 5 mm spoon pins included 	<ul style="list-style-type: none"> • 3/4" thick veneered plywood adjustable shelves – half depth in base cabinets • 5 mm spoon pins included
I END PANELS	<ul style="list-style-type: none"> • 1/2" thick plywood end panels with exterior finish to match • UV coated, natural birch interior 	<ul style="list-style-type: none"> • 1/2" thick plywood end panels with exterior finish to match • UV coated, natural birch interior
J TOP/BOTTOM PANELS	<ul style="list-style-type: none"> • 1/2" thick plywood captured top and bottom • UV coated, natural birch interior 	<ul style="list-style-type: none"> • 1/2" thick plywood captured top and bottom • UV coated, natural birch interior
K BACK PANELS	<ul style="list-style-type: none"> • UV coated plywood back panel 	<ul style="list-style-type: none"> • UV coated plywood back panel
L CONSTRUCTION	<ul style="list-style-type: none"> • All plywood cabinet construction • QuickBuild® Dovetail / Pocket screw assembly system • 3/4" thick solid wood corner braces • 4-1/2" high toe kick 	<ul style="list-style-type: none"> • All plywood cabinet construction • QuickBuild® Dovetail / Pocket screw assembly system • 3/4" thick solid wood corner braces • 4-1/2" high toe kick



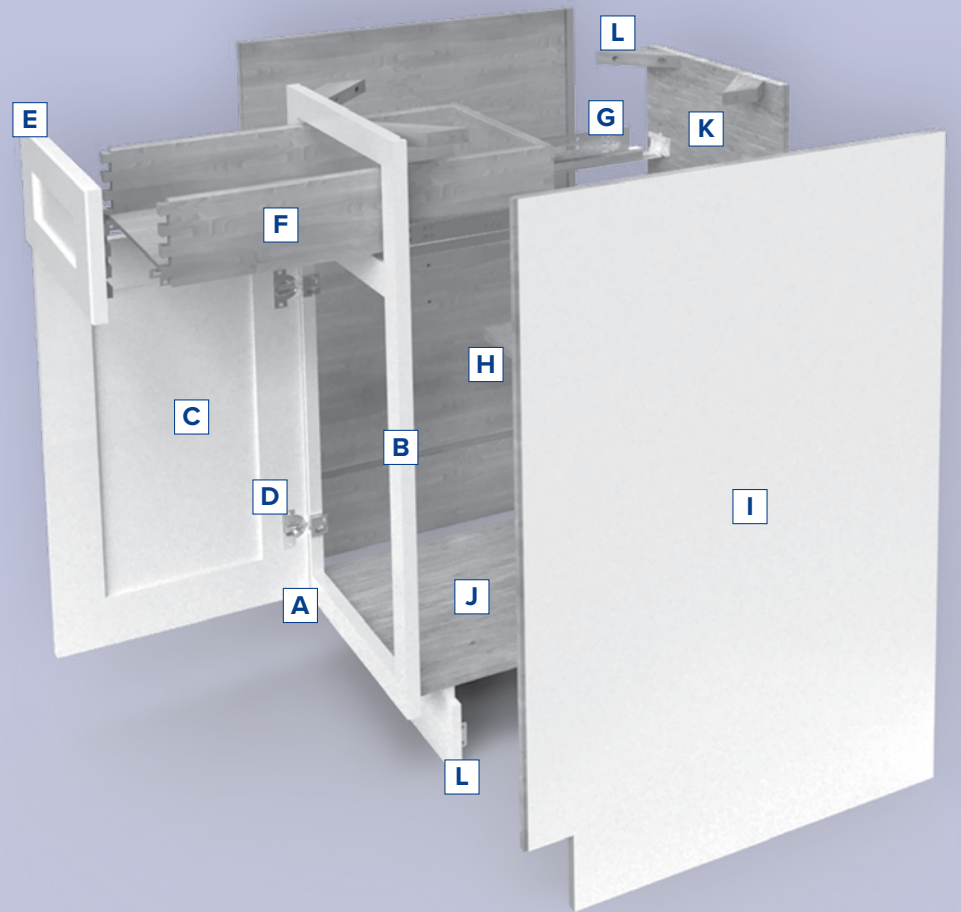
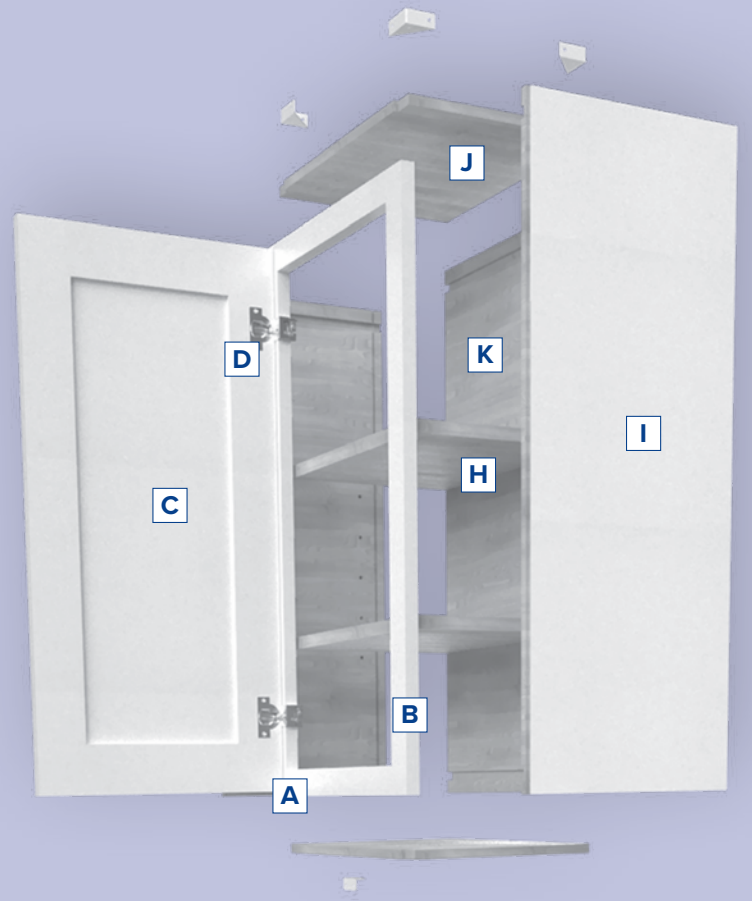

Cabinet Lineup

WALL CABINETS

12" deep except where noted
 42" high wall cabinets will have 3 shelves
 *39" and 42" widths will have a vertical center stile unless otherwise noted

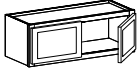

Double Door
 12" Height
 30", 33", 36",
 or *39" Width

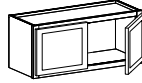

Double Door
 15" Height
 30", 33", 36",
 or *39" Width

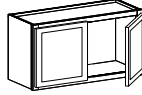

Double Door
 18" Height
 21", 24", 30", 33", 36",
 or *39" Width

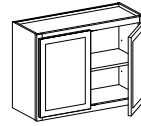

Double Door
 24" Height
 30", 33", 36", or *39" Width

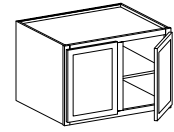

Deep Double Door
 18" or 24" Height • 24" Depth
 36" or *39" Width
 18" Height does not have shelf

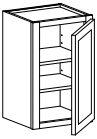

Single Door
 30" Height
 9", 12", 15", 18", or 21" Width

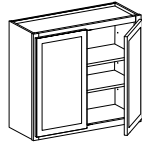

Double Door
 30" Height
 24", 27", 30", 33",
 36", *39", or *42" Width

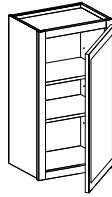

Single Door
 36" Height
 9", 12", 15", 18", or 21" Width

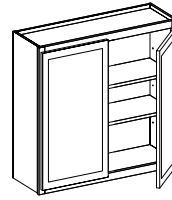

Double Door
 36" Height
 24", 27", 30", 33",
 36", *39", or *42" Width

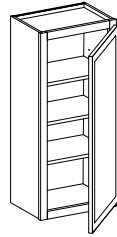

Single Door
 42" Height
 9", 12", 15", 18", or 21" Width

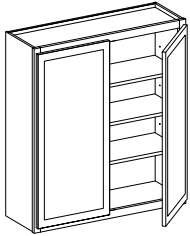

Double Door
 42" Height
 24", 27", 30", 33",
 36", *39", or *42" Width

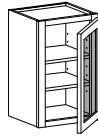

Single & Double Glass Door
 Matching Finish Color Interior
 30" Height
 15", 18", 30", or 36" Width

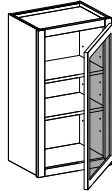

Single & Double Glass Door
 Matching Finish Color Interior
 36" Height
 15", 18", 30", or 36" Width

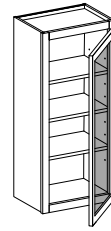

Single & Double Glass Door
 Matching Finish Color Interior
 42" Height
 15", 18", 30", or 36" Width

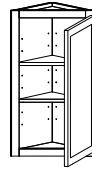

Wall End Single Door
 30", 36", or 42" Height
 12" Width

Glass door wall cabinets only available in the Premier Collection

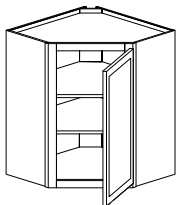

Diagonal Corner
 30", 36", or 42" Height
 12 or 15" Depth
 24" or 27" Width

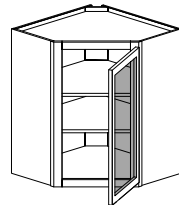

Diagonal Corner Glass Door
 Matching Finish Color Interior
 30", 36" or 42" Height
 12 or 15" Depth
 24" or 27" Width

Glass door wall cabinets only available in the Premier Collection

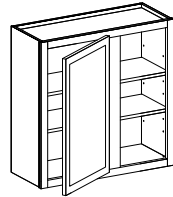

Universal Blind Corner
 30", 36", or 42" Height
 30"-33" Width

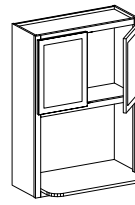

Microwave Wall Cabinet
 Extended Shelf
 36" Height
 30" Width

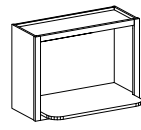

Microwave Wall Cabinet
 Extended Shelf
 18" Height
 30" Width

BASE CABINETS

24" deep, 34-1/2" high
 except where noted

*39" and 42" widths will
 have a vertical center stile
 unless otherwise noted

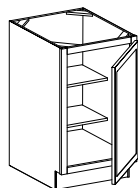

**Full Height
 Single Door**
 9", 12", 15", or 18" Width

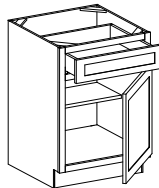

**Single Door
 and Drawer**
 12", 15", 18", or 21" Width

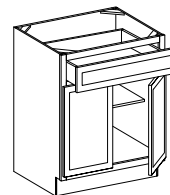

**Double Door and
 Single Drawer**
 24", 27", or 30" Width

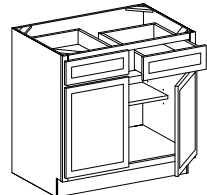

**Double Door and
 Double Drawer**
 33", 36", *39", or *42" Width

Thousands of Cabinet Options in Stock for Quick Delivery

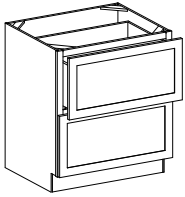

Double Drawer
30" or 36" Width

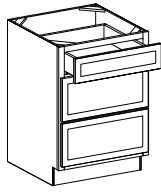

Triple Drawer
12", 15", 18", 21", 24", 30",
or 36" Width

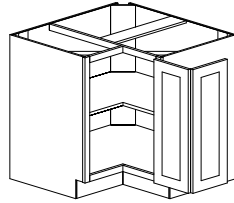

Base Corner Cabinet
33" or 36" Width
(Lazy Susan inserts available)

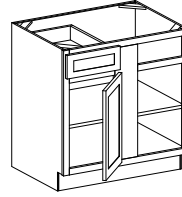

**Universal Blind
Base Corner**
39"-42", 42"-45", or
45"-48" Width

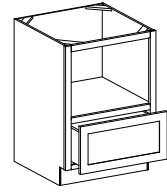

**Microwave Base
Cabinet with Drawer**
30" Width

SINK BASE CABINETS

24" deep, 34-1/2" high
except where noted.

*39" and 42" widths will
have a vertical center stile
unless otherwise noted

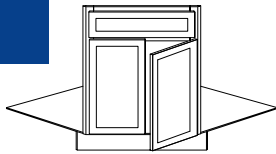

**Corner Sink Front
Double Door**
24" Depth
(2-piece bottom panel)

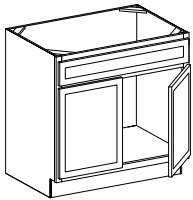

**Sink Base
Double Door**
30", 33", 36", or 39" Width

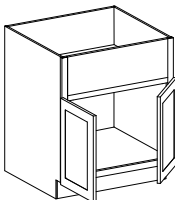

**Farmhouse Sink
Base Double Door**
36" or 39" Width
(No center stile)

TALL CABINETS

24" deep except
where noted.

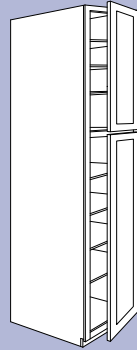

**Utility/Pantry
Single Door**
84", 90" (6 shelves),
or 96" Height (7 shelves)
18" Width

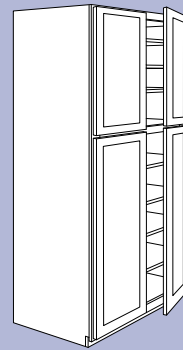

**Utility/Pantry
Double Door**
84", 90" (6 shelves),
or 96" Height (7 shelves)
24" or 30" Width

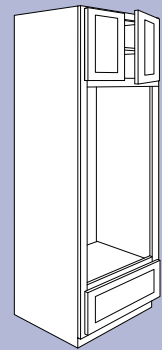

**Oven Double Door,
Single Drawer**
84", 90", or *96" Height
33" Width
*Single shelf in 96" only
(Double Oven Overlay Panel available)

VANITY CABINETS

21" deep, 34-1/2" high
except where noted

*42" widths will have a
vertical center stile

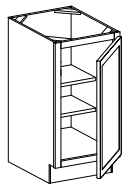

Single Door
12" Width

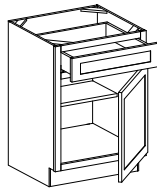

**Single Door
and Drawer**
12", 15", or 18" Width

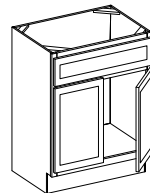

Double Door
24", 27", 30", 33",
or 36" Width

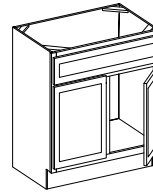

**Double Door
Center Stile**
42" Width

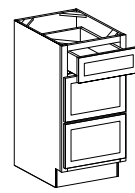

Triple Drawer
12", 15", 18", or
21" Width

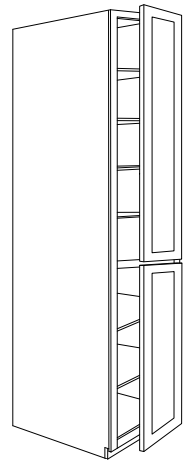

**Linen Single &
Double Door**
84" (6 shelves)
Single: 15" and 18" Width
Double: 24" Width

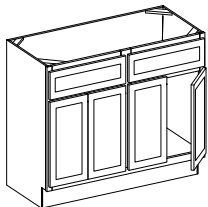

Two Double Door
48" Width

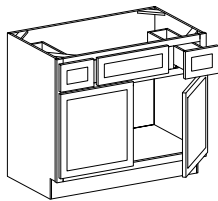

**Double Door and
Double Drawer**
36", 42", or 48" Width

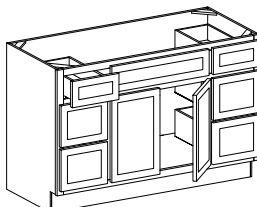

**Double Door and
Six Drawer**
60" Width

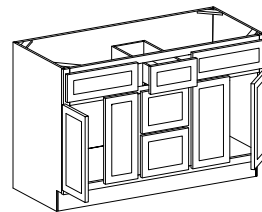

**Two Double Door and
Triple Drawer**
60" Width



Is NorthPoint Cabinetry right for your business?

Do your projects have short timelines?

Want to grow your business without adding overhead?

Is the budget too tight for custom cabinets?

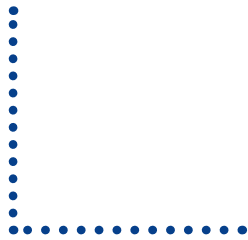

**NORTH
POINT**
C A B I N E T R Y[®]

NorthPoint Cabinetry is a line of professional-grade, quick-assembly cabinets that helps your bottom line. Let us show you how!

What are **QuickBuild**[®] Cabinets?



Dovetail + Pocket Screws = QuickBuild[®]

Basic assembly of our cabinets is as simple as sliding the panels together and securing with pocket screws. You don't need extra fasteners to hold the panels in place, and conveniently placed pocket screws will reduce the average time you spend on each cabinet.

**How fast can
you build a
cabinet?**



One of our cabinets takes about 8 minutes* to assemble (many do it in 4). You can build a kitchen or bathroom in record time!



Scan the QR code to view our Quick Assembly Video.
<https://delivr.com/2kcvh>



Resources

Website



Scan the QR code or visit
NorthPointCabinetry.com

Video



Scan the QR code or visit
<https://delivr.com/2z5tf>

Warranty



Scan the QR code or visit
<https://delivr.com/29q3j>

